

LCPC 100-12 GEL BATTERY

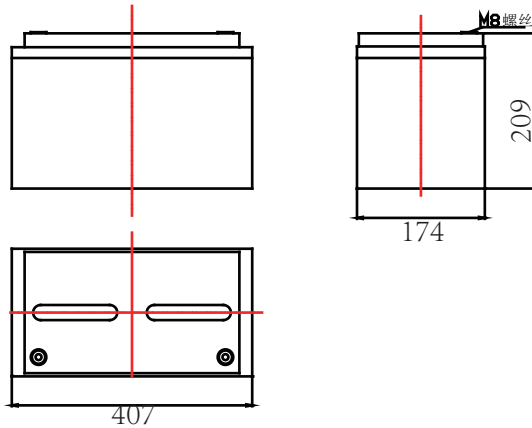

Features

“CNBM” battery ,Maintenance free and easy to use, Contemporary advanced technology research and development of new high-performance batteries,It can be widely used in solar energy , wind energy , telecommunication systems , off-grid systems , UPS and other fields.The designed life for the battery could be eight years up for float use.

Technology data

Reted Voltage	Capacity (10hr,1.80V/Cell)	Weight	Max Discharge Current	Max Charge Current	Self-Discharge (25℃)	Recommended Using Temperature	Cover Material
12V	100Ah	31.5Kg	30I10A (3min)	≤0.25C10	≤3%/month	15℃~25℃	ABS
Using Temperature		Charge Voltage (25℃)	Charge Mode(25℃)		Cycle life	Capacity Affected by Temperature	
Discharge:-45℃~50℃ Charge:-20℃~45℃ Storage:-30℃~40℃		Float Charge: 13.5V-13.8V Average Charge: 14.1V-14.4V	Float Charge:2.275±0.025V/Cell Temperature Compensation Coefficient :±3 mV/Cell ℃ Cycle Charge:2.45±0.05V/Cell Temperature Compensation Coefficient: ±5 mV/Cell ℃		100%DOD 572times 50%DOD 1422 times 30%DOD 2218times	105 % @ 40℃ 85 % @ 0℃ 60 % @ -20℃	

Certificate

ISO9001
ISO14001
CE
CGC
TLC

High and New Technology Products Certification

Standards:

GB/T 19638.2-2005
YD/T799-2002
JISC8704-2:1999

Different discharge time at different terminal Voltage,discharge time(Amps,25)

Constant current discharge coefficient (25℃, A)									
Terminal Voltage (v/Cell)	1H	3H	5H	10H	20H	50H	100H	120H	240H
1.7	53.10	24.14	16.13	10.41	5.38	2.26	1.23	1.09	0.57
1.75	52.04	23.89	15.85	10.26	5.25	2.17	1.15	1.01	0.53
1.8	51.00	23.67	15.60	10.00	5.13	2.10	1.10	0.95	0.51
1.85	48.96	23.53	15.30	9.59	4.88	2.01	1.03	0.89	0.46
1.9	47.01	23.33	15.07	9.39	4.79	1.95	0.99	0.85	0.43
1.95	44.94	22.86	14.76	8.87	4.46	1.81	0.94	0.81	0.41



Performance characteristics

Temperature and Service life

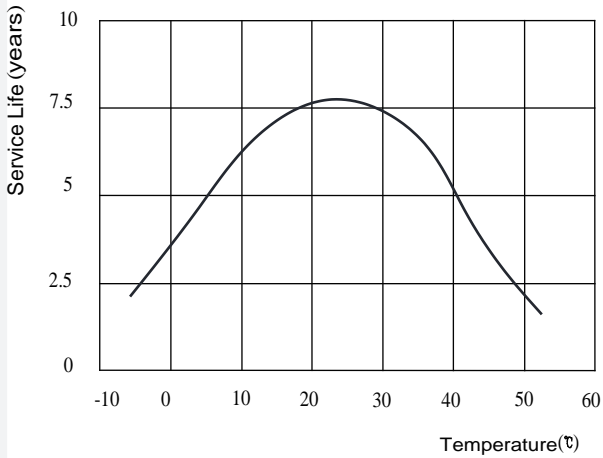

Discharge characteristics at Various Rates (25°C/77°F)

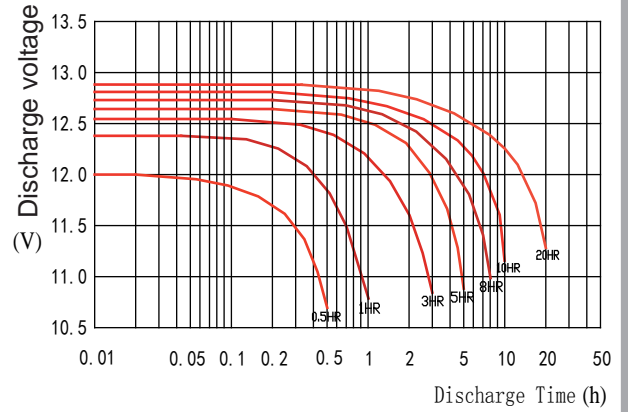

Temperature and discharge capacity

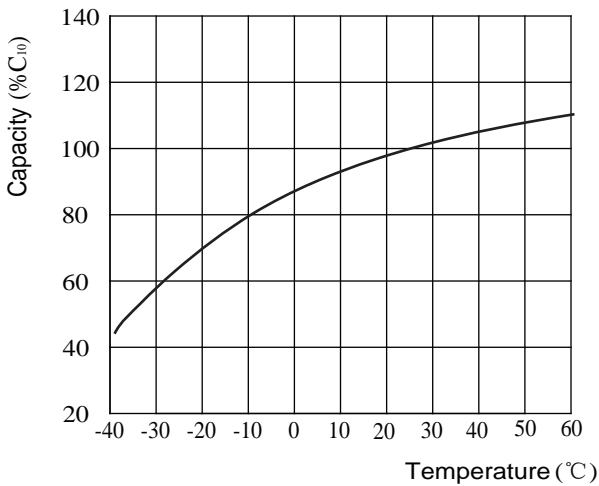

self discharge parameters characteristics

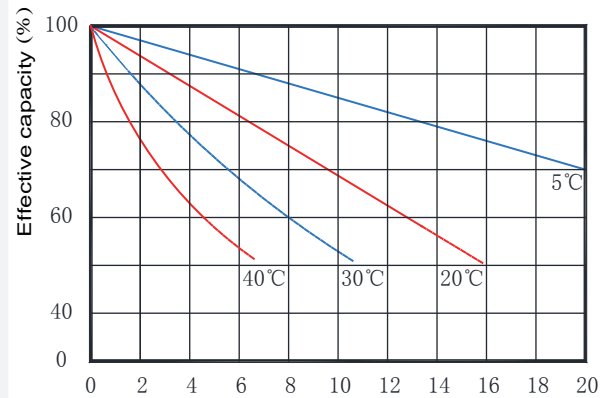

Constant-potential charge

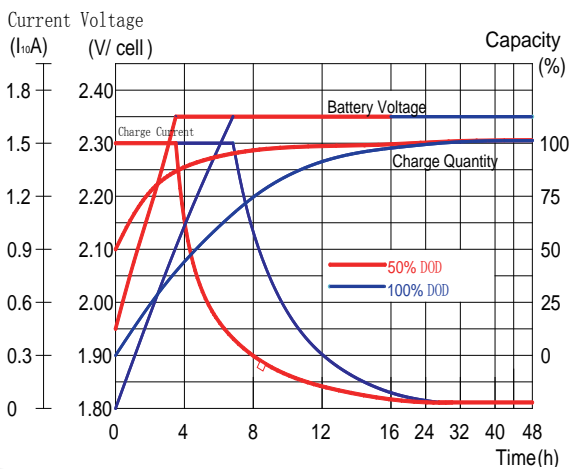

Cycle Service Life (25°C/77°F)

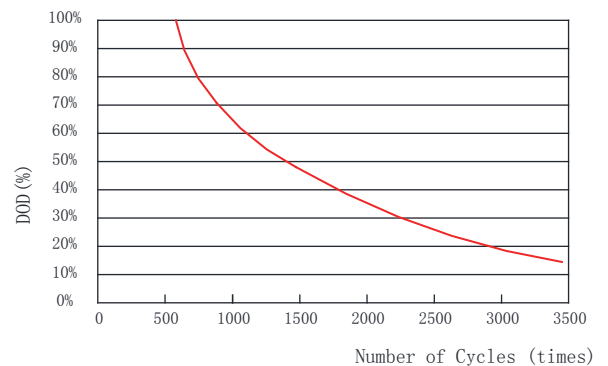

Note The above data are average values, and can be obtained within 3 charge/discharge cycles. These are not minimum values. Cell and battery designs/specifications are subject to modification without notice.



LCPC 200-12 GEL BATTERY



端子型号

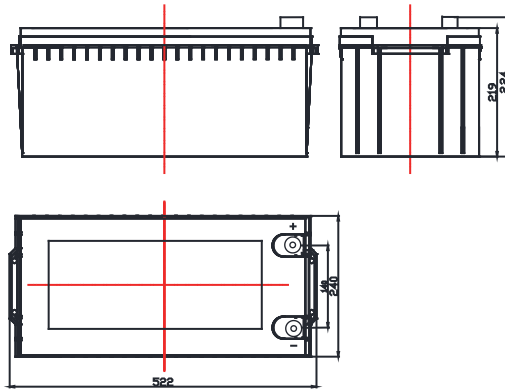
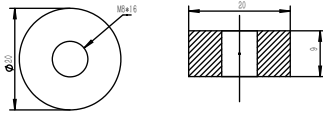

Features

CNBM" battery ,Maintenance free and easy to use, Contemporary advanced technology research and development of new high-performance batteries,It can be widely used in solar energy , wind energy , telecommunication systems , off-grid systems , UPS and other fields.The designed life for the battery could be eight years up for float use.

Technology data

Reted Voltage	Capacity (10hr,1.80V/Cell)	Weight	Max Discharge Current	Max Charge Current	Self-Discharge (25℃)	Recommended Using Temperature	Cover Material
12V	200Ah	59Kg	30I10A (3min)	≤0.25C10	<3%/month	15℃~25℃	ABS
Using Temperature		Charge Voltage (25℃)	Charge Mode(25℃)		Cycle life	Capacity Affected by Temperature	
Discharge: -45℃~50℃ Charge: -20℃~45℃ Storage: -30℃~40℃		Float Charge: 13.5V-13.8V Average Charge: 14.4V-14.7V	Float Charge:2.275±0.025V/Cell Temperature Compensation Coefficient :±3 mV/Cell ℃ Cycle Charge:2.45±0.05V/Cell Temperature Compensation Coefficient: ±5 mV/Cell ℃		100%DOD 572times 50%DOD 1422 times 30%DOD 2218times	105 % @ 40℃ 85 % @ 0℃ 60 % @ -20℃	

Certificate

ISO9001
ISO14001
CE
CGC
TLC

High and New Technology Products Certification

Standards:

GB/T 19638.2-2005
YD/T799-2002
JISC8704-2:1999

Different discharge time at different terminal Voltage,discharge time(Amps,25)

Constant current discharge coefficient (25℃, A)									
Terminal Voltage (v/Cell)	1H	3H	5H	10H	20H	50H	100H	120H	240H
1.7	106.20	48.28	32.27	20.81	10.75	4.52	2.45	2.17	1.15
1.75	104.08	47.79	31.69	20.52	10.50	4.35	2.29	2.03	1.07
1.8	102.00	47.33	31.20	20.00	10.25	4.20	2.20	1.89	1.01
1.85	97.92	47.07	30.60	19.17	9.75	4.03	2.05	1.77	0.92
1.9	94.01	46.65	30.15	18.77	9.58	3.91	1.99	1.69	0.87
1.95	89.88	45.72	29.52	17.73	8.92	3.63	1.88	1.61	0.83



Performance characteristics

Temperature and Service life

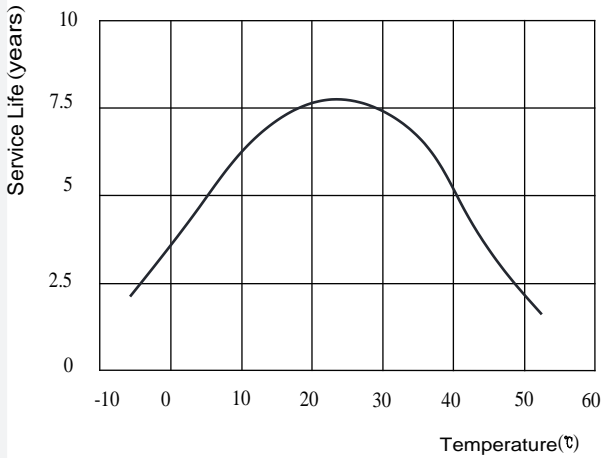

Discharge characteristics at Various Rates (25°C/77°F)

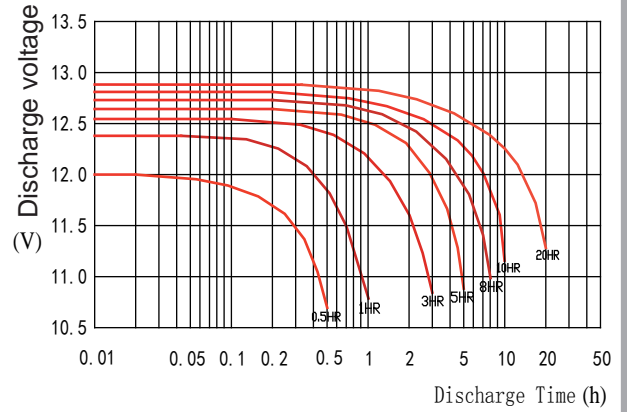

Temperature and discharge capacity

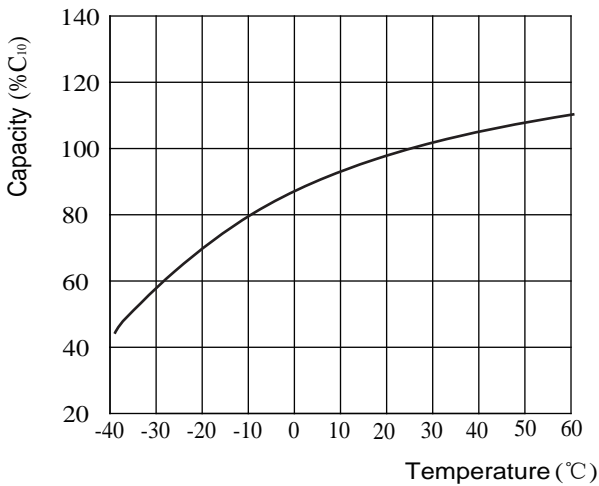

self discharge parameters characteristics

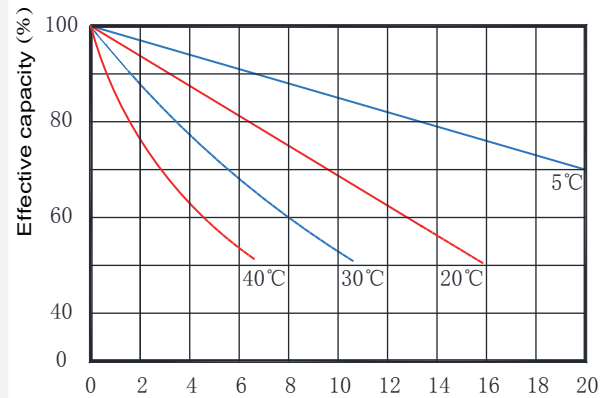

Constant-potential charge

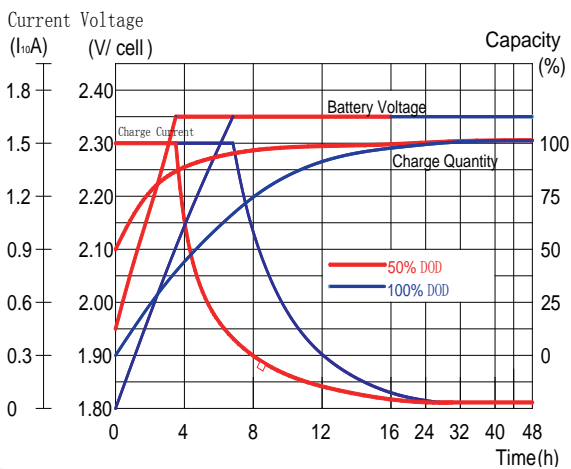

Cycle Service Life (25°C/77°F)

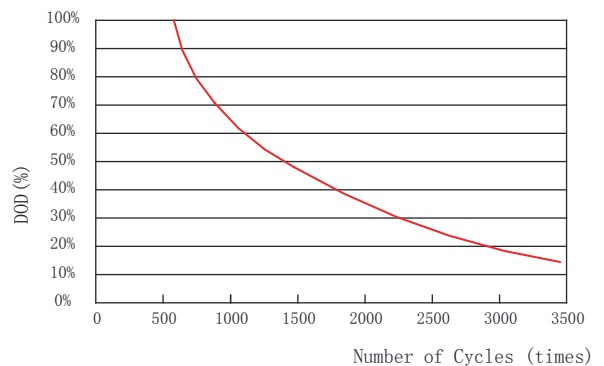

Note The above data are average values, and can be obtained within 3 charge/discharge cycles. These are not minimum values. Cell and battery designs/specifications are subject to modification without notice.

